

Product Type: 7/8 circular connector

Product Name: M7-8U05C-MPBRCU-001

Product Description: M7/8 Male panel mount connector

Product Size

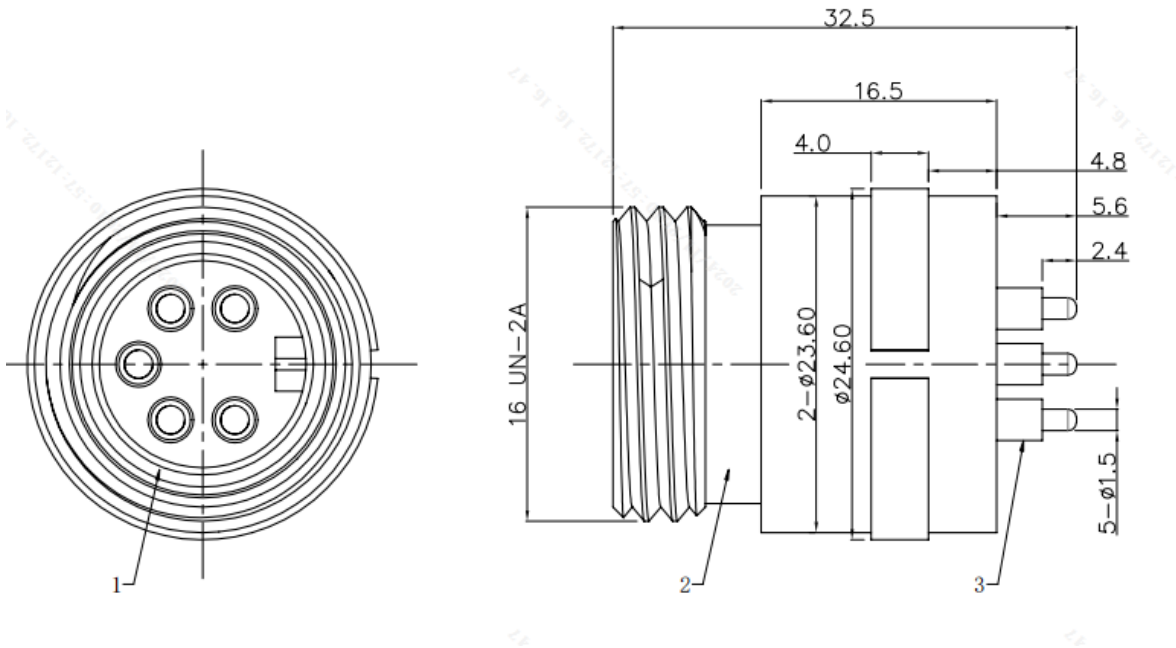

Parameters

⌘ SUPU ID	M7-8U05C-FPBRCU-001
⌘ Number of connections	5
⌘ Protection Level	IP67
⌘ Thread type	M7/8
⌘ Category	Male

☞ Coding	/
☞ Connection method	panel mount
☞ Mechanical endurance	≥100
☞ Standards	/

Technical data

☞ IEC Rated Current	300V DC
☞ IEC Rated Voltage	8A
☞ Insulation Resistance	≥100MΩ
☞ Contact resistance	<10mΩ
☞ Contact/surface material	CuZn/Ni/Au
☞ Contact carrier material	PA
☞ Screw/nut material	CuZn
☞ Sealing material	NBR

Commercial data

☞ Order No	M7/8U05C-MPBRCU-001
------------	---------------------

Ningbo SUPU Electronics Co., Ltd.

Address: No. 150, Xinxing 4th Road, High-tech Industrial Development Zone,

Cixi City, Zhejiang Province, China

Zip code: 315303

Switchboard: +86 574-63288158

Fax: +86 574-63288170

E-mail:supucontact@supu.cn

Service Hotline: 400-626-6336



Wechat

Date:2026-04-26 07:15

The right to modify data belongs to SUPU.