

Product Type: Spring-cage terminal

Product Name:254331

Product Description: Connection method:Spring-cage connection,IEC Rated Current:24A,IEC Rated Voltage:800V,Number of connections:4,Number of levels : 1,Cross section:28-12AWG

Product Size

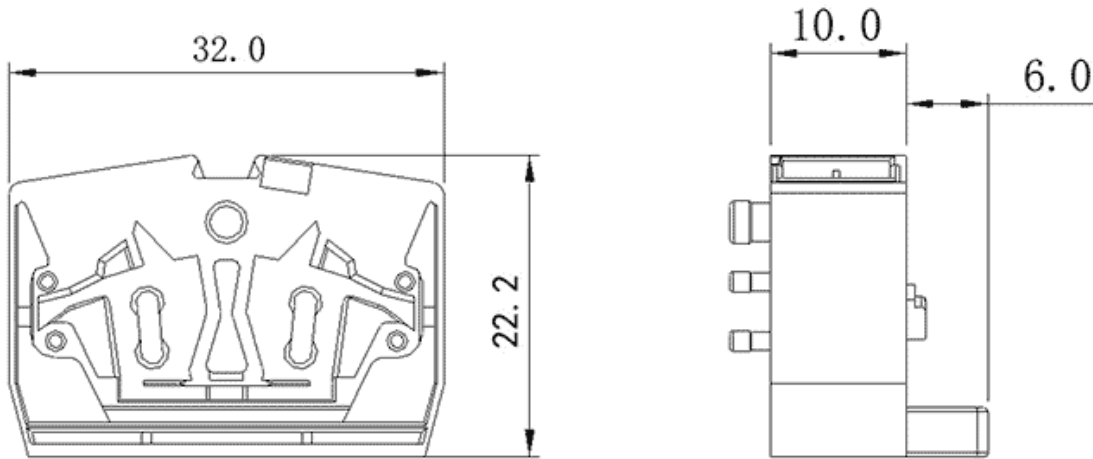

Parameters

| | |
|-------------------------|--------|
| ⌘ SUPU ID | 254331 |
| ⌘ Width | 10mm |
| ⌘ Number of levels | 1 |
| ⌘ Number of connections | 4 |

| | |
|--|------------------------|
| ☞ Connection method | Spring-cage connection |
| ☞ Protection Level | IP20 |
| ☞ Insulation material | PA66 |
| ☞ Insulation material group | I |
| ☞ Contact material | Copper alloy |
| ☞ Contact plating | Sn,Plated |
| ☞ Ambient temperature (operation) | -40°C~105°C |
| ☞ Ambient temperature (assembly) | -5°C~70°C |
| ☞ Ambient temperature (storage) | -25°C~60°C |
| ☞ Permissible humidity (storage/transport) | 30%~70% |

Commercial data

| | |
|------------|--------|
| ☞ Order No | 254331 |
|------------|--------|

Ningbo SUPU Electronics Co., Ltd.

Address: No. 150, Xinxing 4th Road, High-tech Industrial Development Zone,

Cixi City, Zhejiang Province, China

Zip code: 315303

Switchboard: +86 574-63288158

Fax: +86 574-63288170

E-mail:supucontact@supu.cn

Service Hotline: 400-626-6336



Wechat

Date:2026-04-27 03:18

The right to modify data belongs to SUPU.