

Product Type: Heavy-duty Connector Inserts

Product Name:SDD-108-MC

Product Description: SDD Series,108-pole,Ground,Male,Crimp connection

Product Size

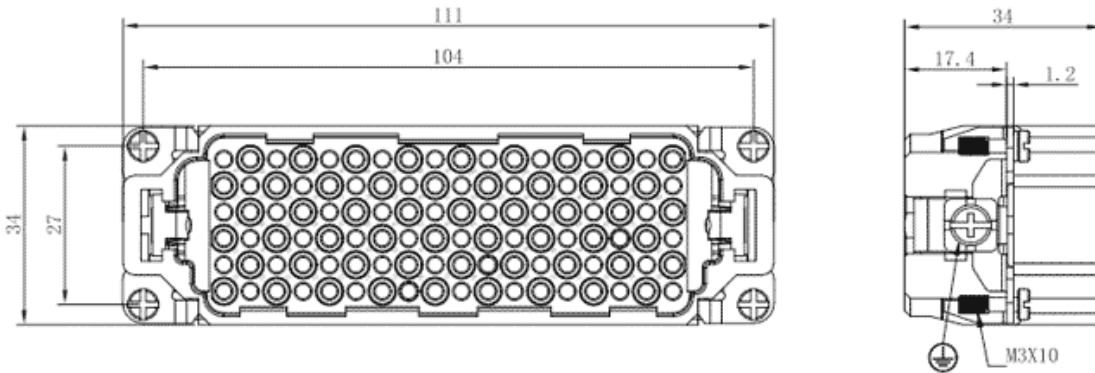

Parameters

☞ SUPU ID	SDD-108-MC
☞ Number of connections	108
☞ Operating temperature range	-40°C~+125°C
☞ Color	Grey

☞ Core number	108
☞ Category	Male Insert
☞ Connection method	Crimp terminal
☞ Mechanical endurance	≥500

Technical data

☞ IEC Rated Current	10A
☞ IEC Rated Voltage	250V
☞ Degree of pollution	3
☞ Contact/surface material	Copper Alloy/Hard-gold, Hard-silver Plated
☞ Contact carrier material	PC
☞ Sealing material	NBR
☞ Insulation resistance	≥1010Ω
☞ Contact resistance	≤3mΩ
☞ Rated pulse voltage	4KV
☞ Wire Specification	0.14-2.5mm ² /26-14 AWG

Commercial data

☞ Order No	SDD-108-MC
☞ Packing unit	PCS
☞ Minimum order quantity	1

Ningbo SUPU Electronics Co., Ltd.

Address: No. 150, Xinxing 4th Road, High-tech Industrial Development Zone,

Cixi City, Zhejiang Province, China

Zip code: 315303

Switchboard: +86 574-63288158

Fax: +86 574-63288170

E-mail:supucontact@supu.cn

Service Hotline: 400-626-6336



Wechat

Date:2026-03-15 10:21

The right to modify data belongs to SUPU.