

Product Type: Heavy-duty connector pins

Product Name:SCGM-005-0.33

Product Description: 5A gold plated, Male, compatible with 0.33mm²

Product Size

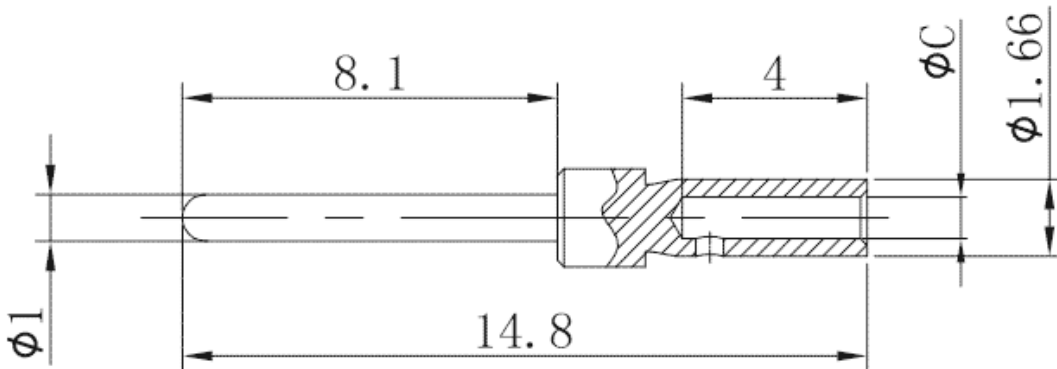

Parameters

☞ SUPU ID	SCGM-005-0.33
☞ Operating temperature range	-40°C~+125°C
☞ Category	cold-pressed pin male terminal
☞ Connection method	Crimp terminal

☞ Mechanical endurance

≥500

Technical data

☞ IEC Rated Current

5A

☞ Contact/surface material

Hard-gold Plated

☞ Pin Material

Copper Alloy

☞ Contact resistance

≤3mΩ

☞ Wire Specification

0.25-0.33mm²/26-22AWG

Commercial data

☞ Order No

SCGM-005-0.33

☞ Packing unit

PCS

☞ Minimum order quantity

1

Ningbo SUPU Electronics Co., Ltd.

Address: No. 150, Xinxing 4th Road, High-tech Industrial Development Zone,
Cixi City, Zhejiang Province, China

Zip code: 315303

Switchboard: +86 574-63288158

Fax: +86 574-63288170

E-mail:supucontact@supu.cn

Service Hotline: 400-626-6336



Wechat

Date:2026-04-26 20:28

The right to modify data belongs to SUPU.