



Product Type: Heavy-duty Connector Housing

Product Name:S10B-SM-4B-2M25-PC

Product Description: S10B Housings,metal,4 blots,surface mounting,2xM25 thread,plastic cover

Product Size

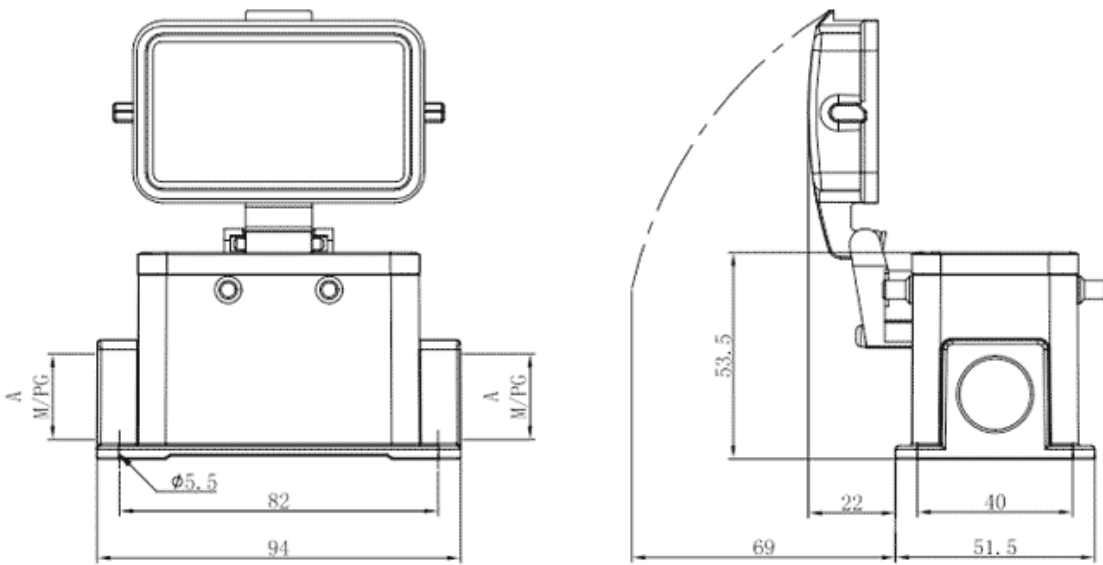

Parameters

☞ SUPU ID	S10B-SM-4B-2M25-PC
☞ Protection Level	IP65
☞ Operating temperature range	-40°C~+125°C
☞ Color	Grey

☞ Thread type	M25
☞ Category	Base
☞ Mechanical endurance	≥500

## Technical data

☞ Sealing material	NBR
☞ Housing Material	Die-Cast Aluminum

## Commercial data

☞ Order No	S10B-SM-4B-2M25-PC
☞ Packing unit	PCS
☞ Minimum order quantity	1

### Ningbo SUPU Electronics Co., Ltd.

Address: No. 150, Xinxing 4th Road, High-tech Industrial Development Zone,

Cixi City, Zhejiang Province, China

Zip code: 315303

Switchboard: +86 574-63288158

Fax: +86 574-63288170

E-mail: [supucontact@supu.cn](mailto:supucontact@supu.cn)

Service Hotline: 400-626-6336



Wechat

---

Date:2026-04-27 03:19

The right to modify data belongs to SUPU.