

Product Type: Heavy-duty Connector Housing

Product Name: S24B-TE-2L.M-M32

Product Description: S24B Hoods, metal, top entry, 2 levers, M32 thread

## Product Size

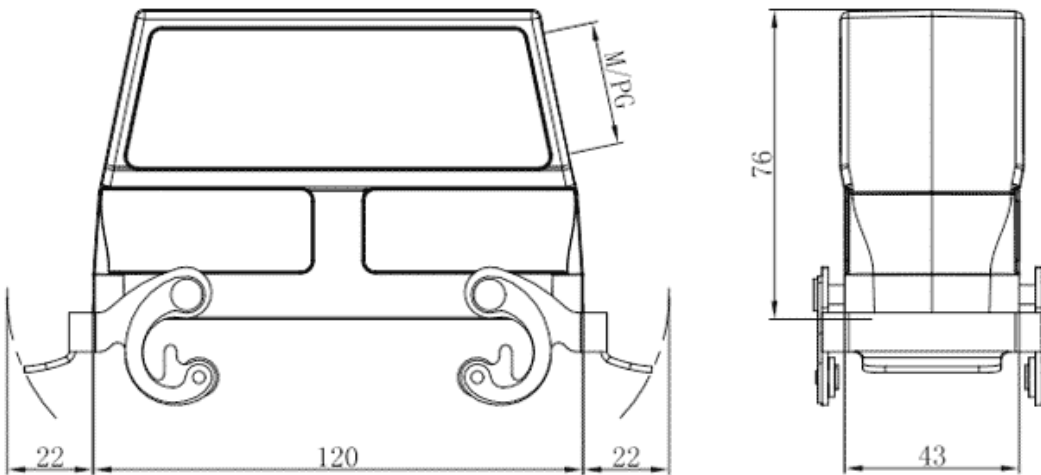

## Parameters

☞ SUPU ID	S24B-TE-2L.M-M32
☞ Protection Level	IP65
☞ Operating temperature range	-40°C~+125°C
☞ Color	Grey

☞ Thread type	M32
☞ Category	Housing
☞ Mechanical endurance	≥500

### Technical data

☞ Sealing material	NBR
☞ Housing Material	Die-Cast Aluminum

### Commercial data

☞ Order No	S24B-TE-2L.M-M32
☞ Packing unit	PCS
☞ Minimum order quantity	1

## Ningbo SUPU Electronics Co., Ltd.

Address: No. 150, Xinxing 4th Road, High-tech Industrial Development Zone,

Cixi City, Zhejiang Province, China

Zip code: 315303

Switchboard: +86 574-63288158

Fax: +86 574-63288170

E-mail: [supucontact@supu.cn](mailto:supucontact@supu.cn)

Service Hotline: 400-626-6336



Wechat

---

Date:2026-04-26 21:03

The right to modify data belongs to SUPU.