



Product Type: Heavy-duty Connector Housing

Product Name:S48B-SM-1L.M-PG29-PC

Product Description: S48B Housings,metal,1 levers,surface mounting,PG29 thread,plastic cover

Product Size

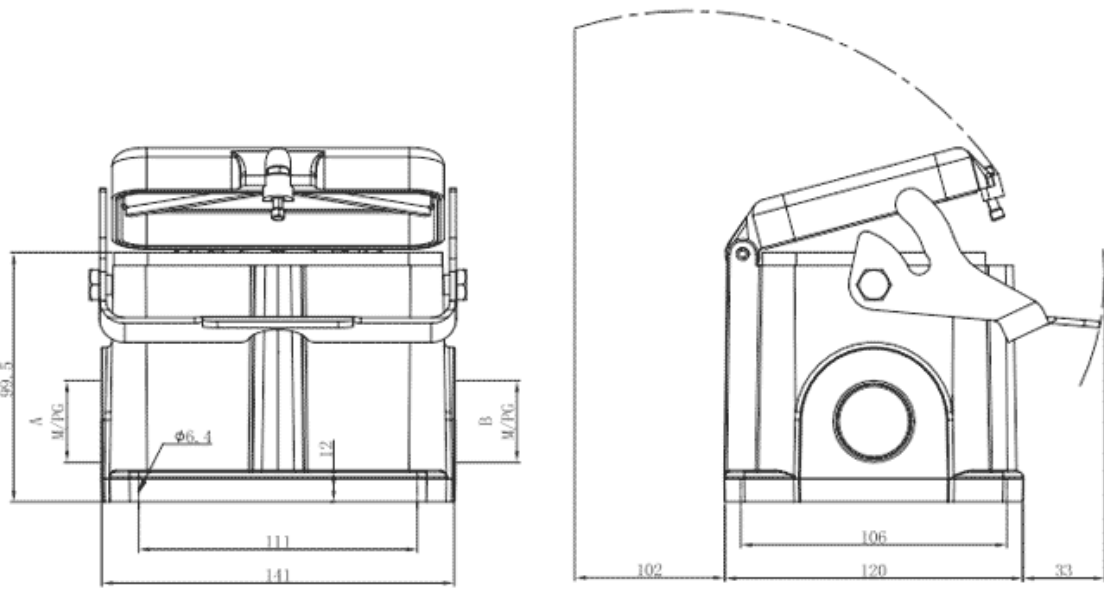

Parameters

☞ SUPU ID	S48B-SM-1L.M-PG29-PC
☞ Protection Level	IP65
☞ Operating temperature range	-40°C~+125°C
☞ Color	Grey

☞ Thread type	PG29
☞ Category	Base
☞ Mechanical endurance	≥500

## Technical data

☞ Sealing material	NBR
☞ Housing Material	Die-Cast Aluminum

## Commercial data

☞ Order No	S48B-SM-1L.M-PG29-PC
☞ Packing unit	PCS
☞ Minimum order quantity	1

### Ningbo SUPU Electronics Co., Ltd.

Address: No. 150, Xinxing 4th Road, High-tech Industrial Development Zone,

Cixi City, Zhejiang Province, China

Zip code: 315303

Switchboard: +86 574-63288158

Fax: +86 574-63288170

E-mail: [supucontact@supu.cn](mailto:supucontact@supu.cn)

Service Hotline: 400-626-6336



Wechat

---

Date:2026-04-25 10:20

The right to modify data belongs to SUPU.