

Product Type: Screw terminal

Product Name:370901

Product Description: Connection method:Screw connection,IEC Rated current:192A,IEC Rated Voltage:1000V,Number of connections:2,Number of levels : 1,Rated cross section:6-3/0AWG

Product Size

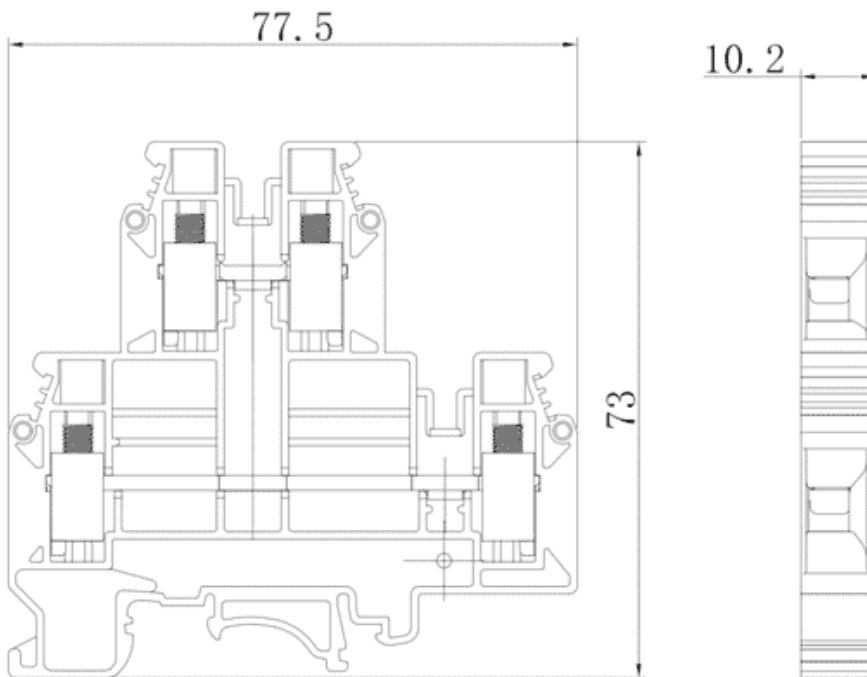

Parameters

☞ SUPU ID	370901
☞ Width	20.4mm
☞ Number of levels	1
☞ Number of connections	2

☞ Connection method	Screw connection
☞ Protection Level	IP20
☞ Insulation material	PA66
☞ Insulation material group	I
☞ Contact material	Copper
☞ Contact plating	Sn,Plated
☞ Ambient temperature (operation)	-40°C~105°C
☞ Ambient temperature (assembly)	-5°C~70°C
☞ Ambient temperature (storage)	-25°C~60°C
☞ Permissible humidity (storage/transport)	30%~70%
☞ Product type	Terminal block of side-entry

Technical data

☞ IEC Rated Current	192A
☞ IEC Rated Voltage	1000V
☞ Overvoltage category	III
☞ Degree of pollution	3
☞ Rated impulse voltage	8kV
☞ UL Rated Current	192A
☞ UL Rated Voltage	600V
☞ Conductor cross section rigid	16-95mm ²
☞ Conductor cross section flexible	25-70mm ²
☞ Conductor cross section flexible,with ferrule	25-70mm ²
☞ Locking screw Specification	M8

☞ Locking screw torque	8-10N.m
☞ Fixed Screw Specification	/
☞ 固定螺钉扭矩	/
☞ Stripping length	24mm
☞ Use group	B/C
☞ Rated cross section	6-3/0AWG
☞ UL Rated Current	192A
☞ UL Rated Current	600V

Commercial data

☞ Order No	370901
------------	--------

Ningbo SUPU Electronics Co., Ltd.

Address: No. 150, Xinxing 4th Road, High-tech Industrial Development Zone,

Cixi City, Zhejiang Province, China

Zip code: 315303

Switchboard: +86 574-63288158

Fax: +86 574-63288170

E-mail:supucontact@supu.cn

Service Hotline: 400-626-6336



Date:2026-04-26 19:12

The right to modify data belongs to SUPU.