



Product Type: M12 Panel Mounting Connector

Product Name: M12D04C-FFHR-UC0.5

Product Description:

Product Size

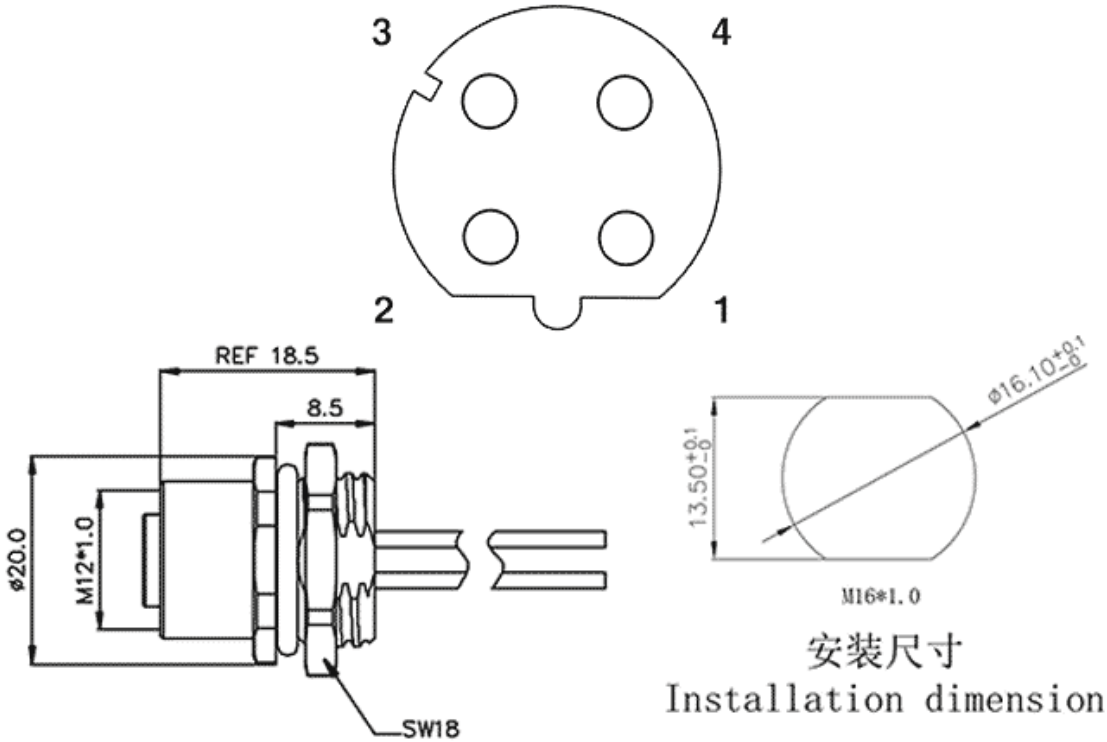

Parameters

☞ SUPU ID	M12
☞ Number of connections	4
☞ Protection Level	IP67
☞ Operating temperature range	-40~+85°C

☞ Mounting Type	板前安装
☞ Thread type	M12X1.0
☞ Category	孔式
☞ Coding	A
☞ Connection method	/
☞ Mechanical endurance	100
☞ Standards	IEC61076-2-101

Commercial data

☞ Order No	M12D04C-FFHR-UC0.5
☞ Packing unit	PCS
☞ Minimum order quantity	1

Ningbo SUPU Electronics Co., Ltd.

Address: No. 150, Xinxing 4th Road, High-tech Industrial Development Zone,

Cixi City, Zhejiang Province, China

Zip code: 315303

Switchboard: +86 574-63288158

Fax: +86 574-63288170

E-mail:supucontact@supu.cn

Service Hotline: 400-626-6336



Wechat

Date:2026-04-29 09:56

The right to modify data belongs to SUPU.