

Product Type: Plug-in terminal-Socket

Product Name:MC-PB3.81H17C-FB-0001

Product Description: Pitch: 3.81mm Rated Voltage : 160V Rated Current: 8A Connection method : Screw connection colour : customizable

## Product Size

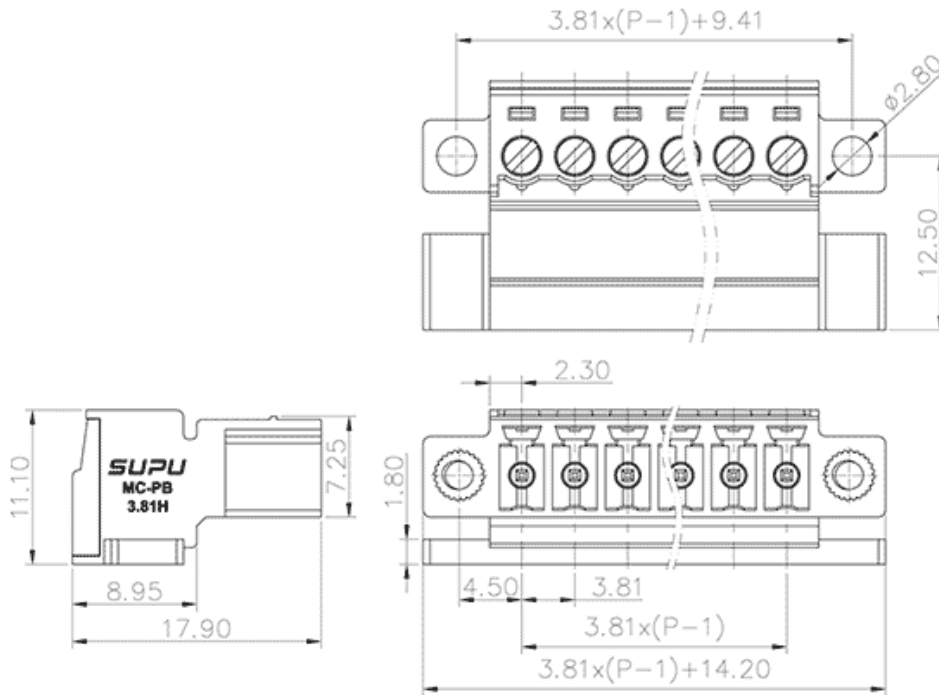

## Parameters

☞ SUPU ID	MC-PB3.81H17C-FB-0001
☞ Pitch	3.81
☞ Number of levels	Single layer
☞ Number of connections	17

☞ Connection method	Screw connection
☞ Protection Level	IP20
☞ Operating temperature range	-40~+105°C
☞ Insulation material	PA66
☞ Insulation material group	I
☞ Contact material	Copper alloy
☞ Contact plating	Sn,Plated
☞ Color	Green/Black/Blue/Grey/Orange/Red

## Technical data

☞ IEC Rated Current	160V
☞ IEC Rated Voltage	8A
☞ Overvoltage category	III III II
☞ Degree of pollution	3 2 2
☞ Rated impulse voltage	2.5KV 2.5KV 2.5KV
☞ UL Rated Current	8A - 8A
☞ UL Rated Voltage	300V - 300V
☞ Conductor cross section rigid	0.2-1.5mm <sup>2</sup>
☞ Conductor cross section flexible	0.2-1.5mm <sup>2</sup>
☞ Conductor cross section flexible,with furrule	0.2-1.5mm <sup>2</sup>
☞ Locking screw Specification	M2
☞ Locking screw torque	0.2~0.25N.m
☞ Stripping length	7-8mm
☞ Use group	B/C/D

Commercial data

☞ Order No

MC-PB3.81H17C-FB-0001

Ningbo SUPU Electronics Co., Ltd.

Address: No. 150, Xinxing 4th Road, High-tech Industrial Development Zone,  
Cixi City, Zhejiang Province, China

Zip code: 315303

Switchboard: +86 574-63288158

Fax: +86 574-63288170

E-mail:supucontact@supu.cn

Service Hotline: 400-626-6336



Wechat