

Product Type: Plug-in terminal-Plug

Product Name:MC-

RAF3.81H17C-I-0001

Product Description: Pitch:3.81mm Rated Voltage : 160V Rated Current:8A Connection method : Screw connection colour : customizable

Product Size

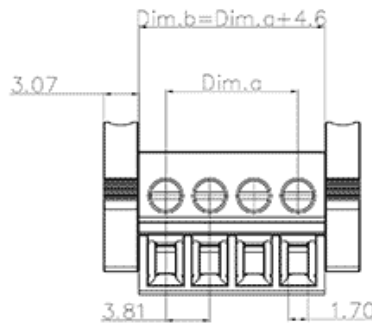
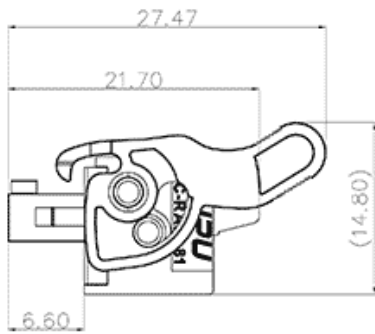
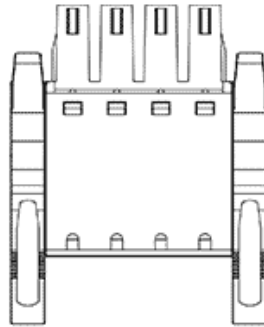

Parameters

⌘ SUPU ID	MC-RAF3.81H17C-I-0001
⌘ Pitch	3.81
⌘ Number of levels	single layer
⌘ Number of connections	17

Connection method	Screw connection
Protection Level	IP20
Operating temperature range	-40~+105°C
Insulation material	PA66
Insulation material group	I
Contact material	Copper alloy
Contact plating	Tin,Plated
Color	Green/Black/Blue/Grey/Orange/Red

Technical data

IEC Rated Current	8A
IEC Rated Voltage	160V
Overvoltage category	III/III/ II
Degree of pollution	3 2 2
Rated impulse voltage	2.5KV 2.5KV 2.5KV
UL Rated Current	8A - 8A
UL Rated Voltage	300V - 300V
Conductor cross section rigid	0.2-1.5mm ²
Conductor cross section flexible	0.2-1.5mm ²
Conductor cross section flexible,with furrule	0.2-1.0mm ²
Locking screw Specification	M2.0
Locking screw torque	0.2N.m
Fixed Screw Specification	-
固定螺钉扭矩	-

☞ Stripping length	8-9mm
☞ Use group	B/C/D
☞ Rated cross section	28~16AWG

Commercial data

☞ Order No	MC-RAF3.81H17C-I-0001
------------	-----------------------

Ningbo SUPU Electronics Co., Ltd.

Address: No. 150, Xinxing 4th Road, High-tech Industrial Development Zone,
Cixi City, Zhejiang Province, China

Zip code: 315303

Switchboard: +86 574-63288158

Fax: +86 574-63288170

E-mail:supucontact@supu.cn

Service Hotline: 400-626-6336



Wechat